

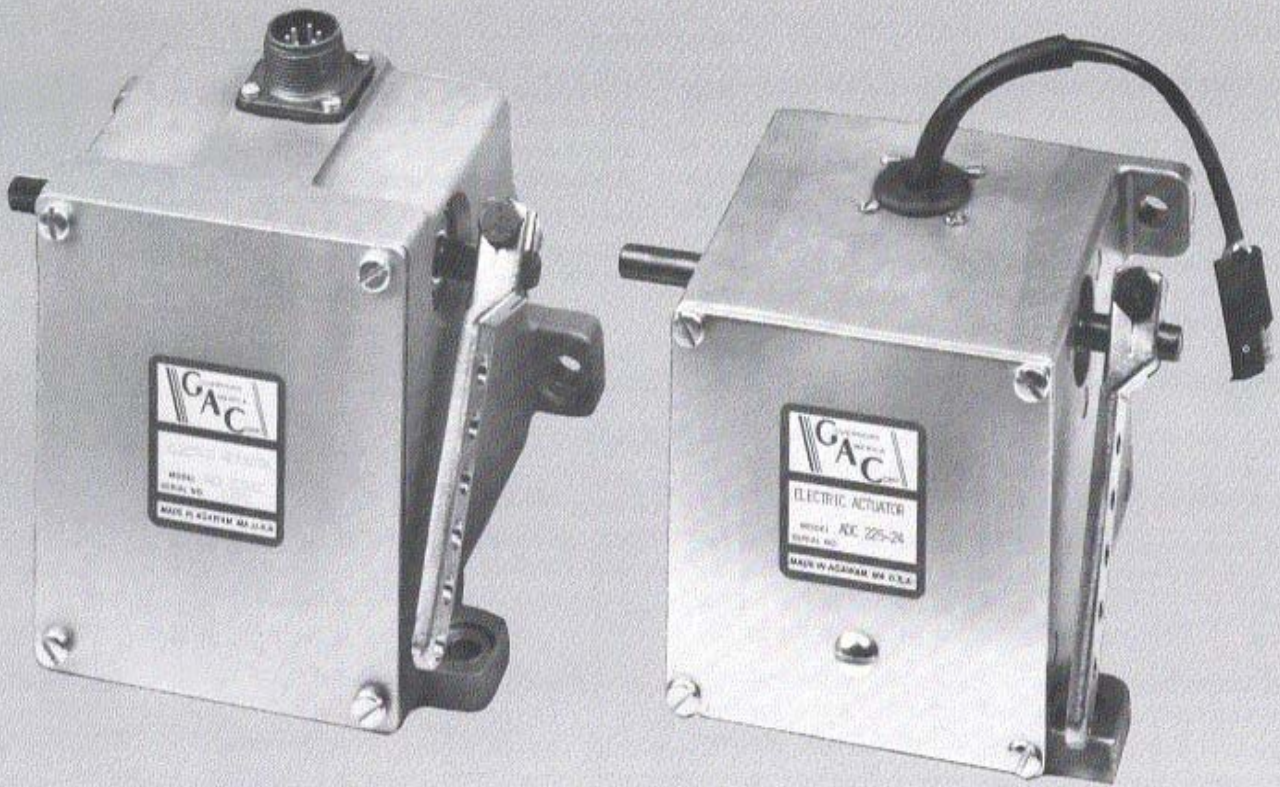

ENGINE GOVERNING SYSTEMS

225 SERIES



ELECTRIC ACTUATOR

INCLUDES MODELS: ACB 225

ADB 225

ADC 225

ADB 225F



GOVERNORS AMERICA CORP. • 720 Silver St. • Agawam, MA 01001-2907, USA

225 SERIES ELECTRIC ACTUATOR

PRODUCT
TECHNICAL
INFORMATION

PTI 2000
SEPTEMBER 1997
MPC

INTRODUCTION

The 225 Series electric actuator is a rotary output, linear torque, proportional servo. This electromechanical actuator is typically used as an engine fuel control positioning device. An internal spring provides fail safe operation by forcing the actuator to the fuel shut off position when the actuator is de-energized. This design combines fast operation, multi voltage usage, wider rotation angles, and proven reliability. The actuator can operate directly from 12, 24, or 32 volt battery supplies.

The speed of operation of the actuator is typically faster than competitive units, thus it provides more stable and rapid response to transient conditions.

Applications include most block pumps, with or without mechanical governors, distributor type pumps, and medium sized carbureted engines. The 25 degrees of rotation expands the application to a wider variety of engines.

DESCRIPTION

The actuator is an electromagnetic servo device which can be integrated into a closed loop control system. An engine control system can be described as follows. An electrical signal is generated by a magnetic speed sensor which is proportional to engine speed. This signal is sent into the electronic speed control unit which compares it to the preset engine speed setting. If the magnetic speed sensor signal and the preset engine speed setting are not equal, a change in current from the speed control unit to the actuator will change the magnetic force in the actuator.

The rotation of the actuator shaft will then adjust the fuel to the engine and cause the engine speed to be equal to the preset engine speed setting. Shaft rotation is proportional to the amount of actuator current and counterbalanced by the internal spring.

Since the design has no sliding parts and is totally sealed, outstanding reliability results. A single compression spring is used to improve reliability. No maintenance is necessary.

DIAGRAM 1a

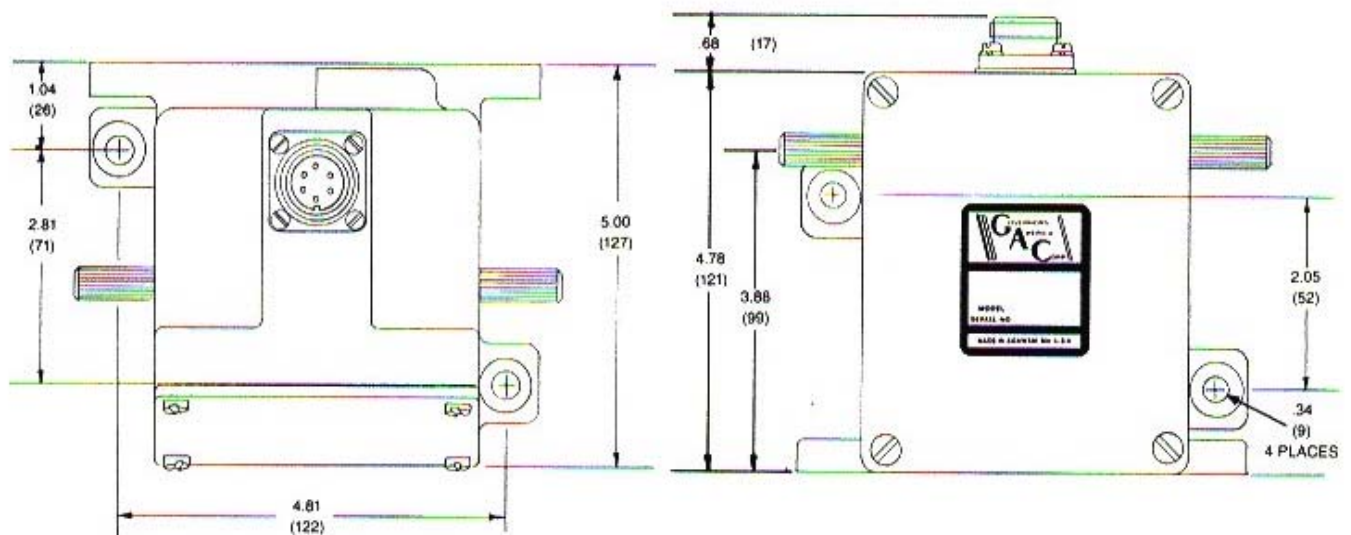

ACB
Actuator Outline Dimensions
Dimensions in: Inches (mm)

DIAGRAM 1b

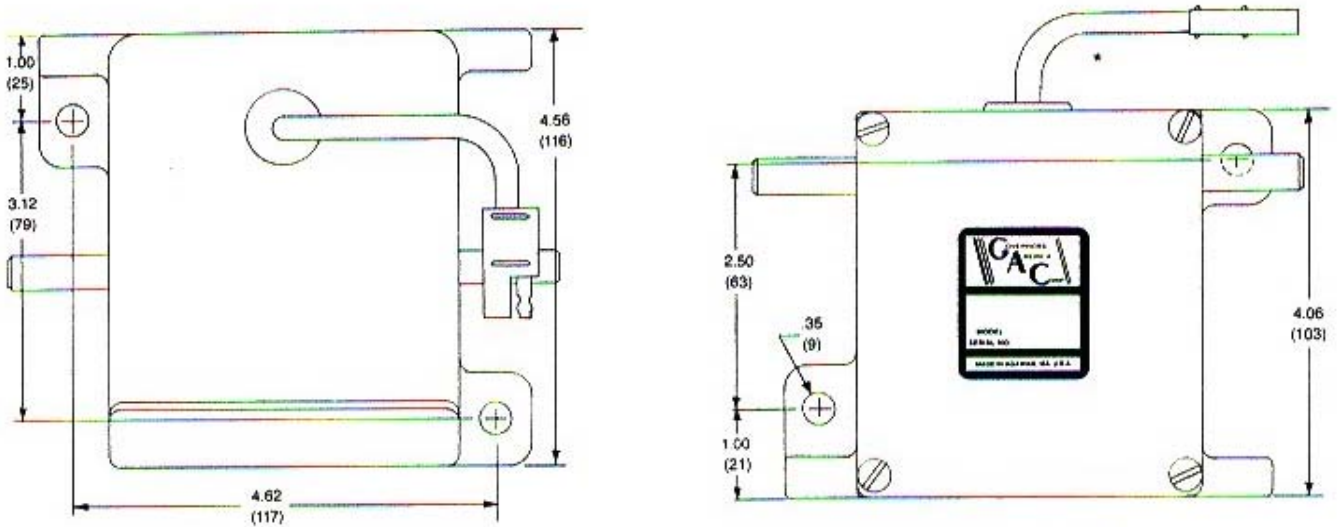

* ADC only

ADB and ADC Actuator Outline Dimensions

SPECIFICATIONS

PERFORMANCE	
Available Torque	See Diagram 2.....Max 2.2 lb-ft (2.7 Nm)
Maximum Operating Shaft Angular Travel	25 ± 1 degree CW/CCW
POWER INPUT	
Operating voltage	12, 24, or 32 VDC
Normal Operating Current	3 A at 12 VDC
.....	1.5 A at 24/32 VDC
Maximum Current-Continuously Rated	8 A at 12 VDC, 9 A for HOS
.....	4 A at 24/32 VDC
ENVIRONMENTAL	
Temperature Range	-65° to +200° F (-54° to +95° C)
Relative Humidity	up to 100%
All Surface Finishes	Fungus proof and corrosion resistant
PHYSICAL	
Dimensions	See Diagram 1
Weight	8.25 lbs. (3.75 kg)
Mounting	Any position, electrical connector at the top preferred
RELIABILITY	
Vibration	up to 20 G @ 50-500 Hz.
Testing	100% Tested
MATING HARDWARE	
Connector ACB 225/ADB 225	EC1000/MS3106R 14S-6S (6 pins)
ADC 225	Supplied with Actuator
Lever	ACB 225/ADB 225/ADC225S LE1400-2
.....	ADC 225 LE1500-2
Rod End Bearings (to attach a 1/4-28THD linkage rod to the lever)	BR 200 (right hand)
.....	BR 201 (left hand)
Wiring Harness ADC 225	Supplied with Actuator
ACB 225/ADB 225	Various Lengths available from GAC

225 SERIES ACTUATOR VARIATIONS

ACB 225/ADB 225	MS3102R 14S-6P CONNECTOR	ADC 225 ...	COMMERCIAL CONNECTOR 12 or 24 VOLTS
-----------------------	--------------------------	-------------	-------------------------------------

DIAGRAM 2

Graph of
Actuator
Torque

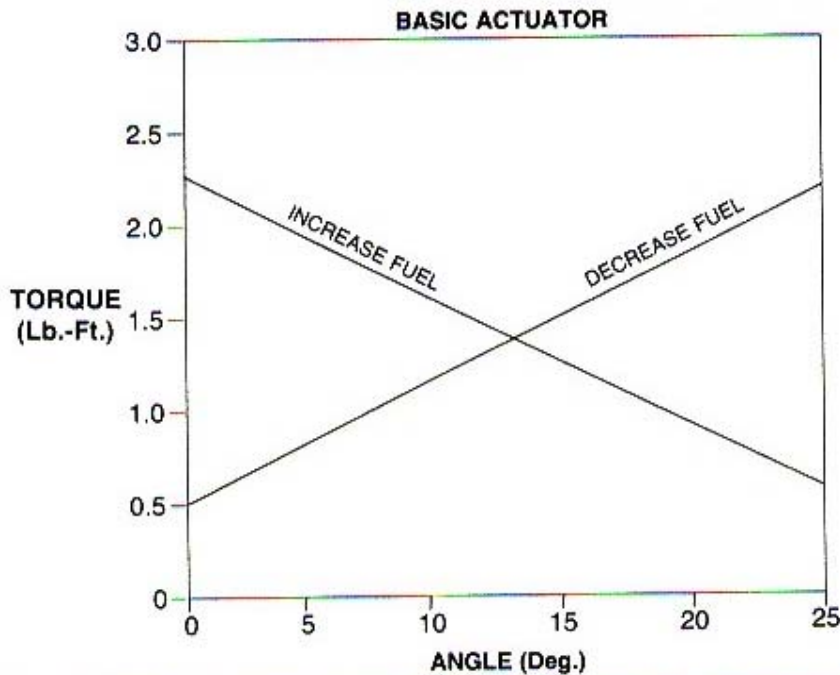

INSTALLATION

The actuator must be rigidly mounted as close as possible to the fuel control lever of the engine. Vibration from the engine will not affect the operation of the actuator. The preferred mounting is with the electrical connector at the top. Applications with the actuator upside down, on its back, or sideways should be avoided.

Linkage arrangement of any actuator system is always important. High quality rod end bearings should be used. Rod end bearings that have high friction can cause instability and require servicing.

Levers and linkage should be sturdy yet low in mass for the fastest speed of response conditions.

Arrangement of the linkage for actuation of the engine fuel control is an important application consideration. For proportional actuators to operate with linear control systems, it is important to obtain a linear relationship between actuator stroke and fuel delivery. The linkage configuration for diesel fuel systems is typically as

illustrated in Diagram 3. The lever on the actuator should be nearly parallel to the pump lever at the mid fuel position for linear fuel control.

For proportional actuators to operate with non-linear systems, it is important to obtain a non-linear relationship between actuator stroke and fuel delivery. Carbureted, PT Pumps (CUMMINS), or other non-linear fuel systems require a non-linear fuel linkage configuration as illustrated in Diagram 4. A non-linear fuel system results when more engine power is developed for a given stroke at positions of low fuel settings than at high fuel settings. In this case the levers should be parallel at full load.

In general, the linkage should be adjusted so that the fuel control lever minimum and maximum fuel stops are used rather than the actuator internal mechanical stops. The actuator should be adjusted so that it operates over at least one half (12 degrees) of its available travel.

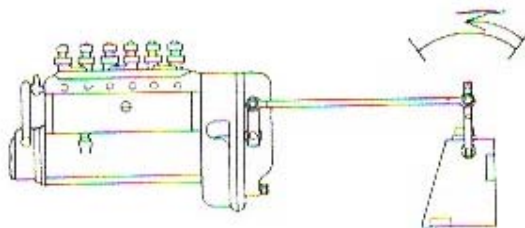

**Fuel Control Lever At Mid Fuel Position
DIAGRAM 3**

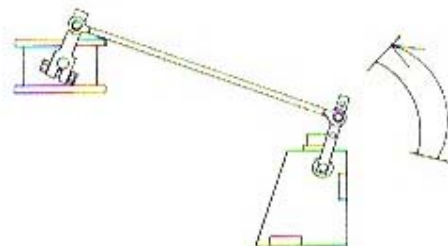

**Carburetor Fuel Valve At Full Fuel Position
DIAGRAM 4**

Wiring

The ADC is prewired for 12 or 24V. Use the included harness to connect the actuator to the speed control. Do not use an ADC on a 32V system.

If an ACB or ADB is used, the mating electrical connector must be wired in a configuration dependent on the system voltage supply. The maximum wire size that will fit into the actuator mating half connector is #16 AWG (1.3 mm sq.). Cable CH 1203, a pre-wired actuator cable harness, is available. It is 12 feet (4 Meters) in length and suitable for use on 12 or 24 volt systems.

For 12 volt applications, note that it is preferable to connect four cables, one to each of the coil wires and wire per Diagram 5. Maximum current is 8 Amps. The recommended wire size is at least #16 AWG (1.3 mm sq.).

DIAGRAM 5
12 Volt Operation

A to C
B to D
A & D to output terminals
of speed control unit

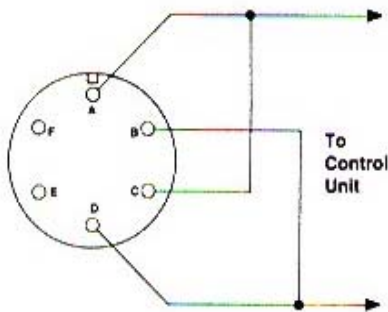

For 24 volt applications, a simple jumper wire between pins B and C at the mating half connector can be made. The remaining two pins, A and D, can be extended to the required length. Maximum current is 4 Amps. The recommended wire size is at least #18 AWG (1.0 mm sq.). See Diagram 6.

DIAGRAM 6
24 Volt Operation

B to C
A & D to output terminals
of speed control unit

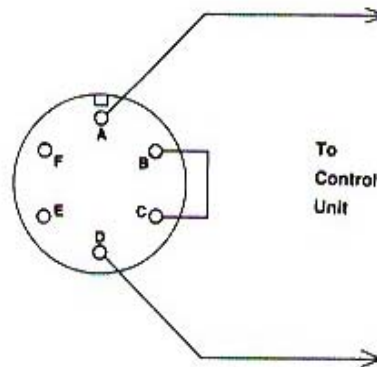

For 32 volt applications, connect the actuator electrical connector as illustrated for 24 Volt operation. A resistor that will drop the remaining voltage above 32 Volts is needed. A 1.5 ohm, 25 watt resistor should be placed in series with pin A of the actuator and the output of the speed control unit. Maximum current is 4 Amps.

Actuator cable harnesses with lengths greater than 10 ft. (3 meters) from the actuator to the speed control unit may introduce current losses which can restrict full rotation of the actuator. In this case, use of a larger gauge wire is required.

For applications where EMI is of concern, shielded cable for the actuator is recommended. Twisting of the cable alone will substantially reduce EMI.

ADB225F Wiring

The ADB225F version of the actuator includes a position sensor. A GAC speed control unit that includes fuel management electronics is required to interface with this sensor.

See the appropriate speed control unit literature for complete wiring information.

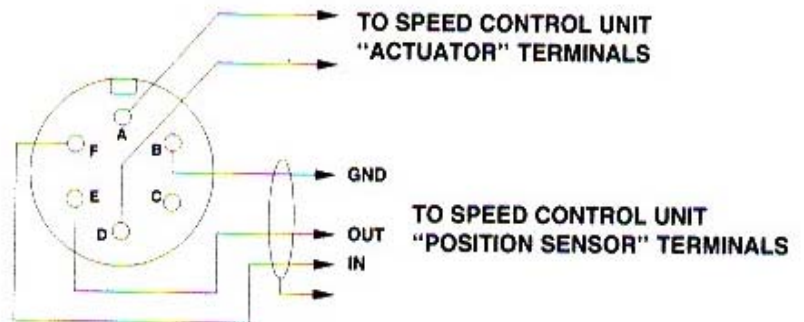

ADJUSTMENTS

WARNING

An overspeed shutdown device, independent of the governor system, should be provided to prevent loss of engine control which may cause personal injury or equipment damage.

Reconfirm that the linkage is not binding and that friction is minimal. Before starting the engine, push the actuator to the full fuel position and release. It should return instantly to the no fuel position without any binding. Once the engine has been started, the linkage can be optimized by temporarily inserting an ammeter in one of the wires between the speed control unit and the actuator or by measuring the voltage across the actuator. Measure the actuator current or voltage at no load and full load. The range and the starting current or voltage are important for optimizing the linkage system. Typical values are shown in the table below for 12 volt and 24 volt systems.

To increase the range of the actuator voltage or current, move the linkage to a lower hole on the actuator lever. A lower range of actuator current than suggested can cause instability or poor performance.

To increase or decrease the no load current or voltage, adjust the length of the link between the actuator and the engine fuel control.

Smaller angles of actuator travel may improve transient performance, but will reduce available force at the fuel control lever. Allowing the actuator to operate through at least one half (12 degrees) of its stroke will usually provide near optimum response.

Actuator Current/Voltage Range Chart

	12 Volts	24 Volts
No Load	2.5 Amps, 4 Volts	1.5 Amps, 12 Volts
Full Load	4 Amps, 6 Volts	2.5 Amps, 18 Volts

TROUBLESHOOTING

If the governor system fails to operate, make the following tests at the actuator mounted connector while moving the actuator through its stroke.

Measure the Resistance ACB 225/ADB 225

A to B	2.5 ohms
C to D	2.5 ohms
A to C	Infinity
A to Housing	Infinity
C to Housing	Infinity

ADC 225

Red to white (12V)	1.25 ohms
Red to white (24V)	5.0 ohms
Red to housing	Infinity
White to housing	Infinity

Energize the actuator to full fuel (follow steps in control unit publication) and manually move the actuator through its range. No binding or sticking should occur.

If the actuator passes these tests, the problem is elsewhere in the system. Refer to the control unit troubleshooting publication.



720 Silver St. • Agawam, MA 01001-2907, USA • (413) 786-5600

FAX (413) 786-5666

e-mail: info@governors-america.com
Internet: www.governors-america.com